

### WorkFit Dual Monitor Kit

#### Dimensions

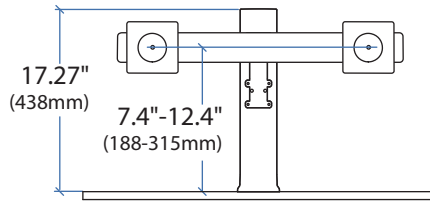

Front View

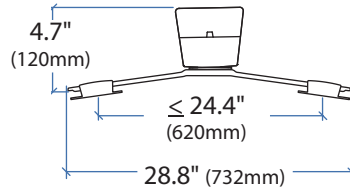

Top View

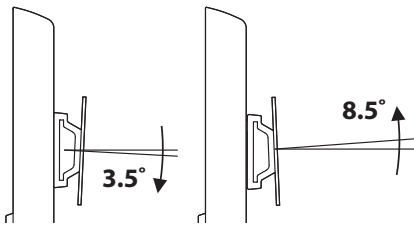
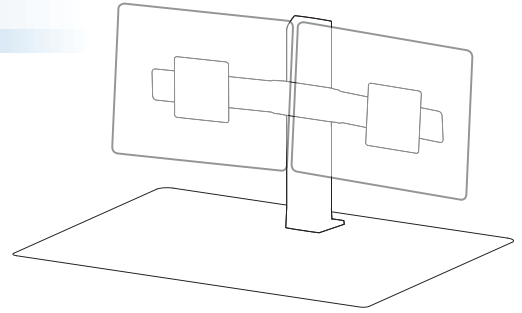

Side View

#### Range of Motion

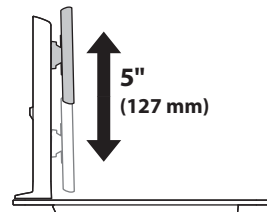

Side View

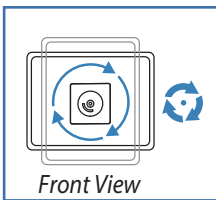

#### WorkFit-PD

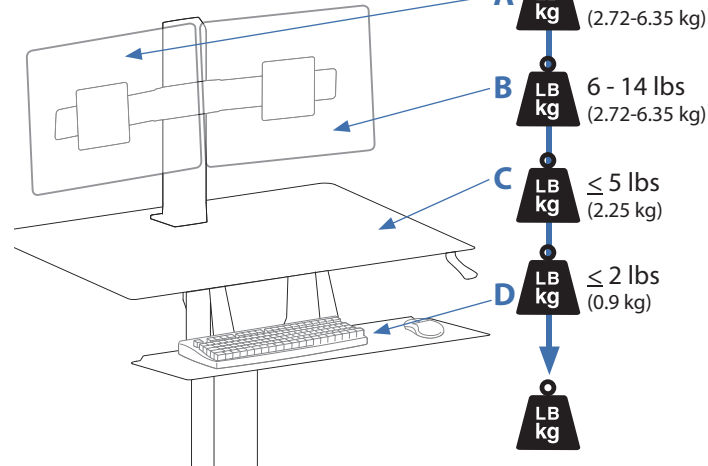

$$A+B+C+D \leq 31 \text{ lbs (14 kg)}$$

#### WorkFit-T

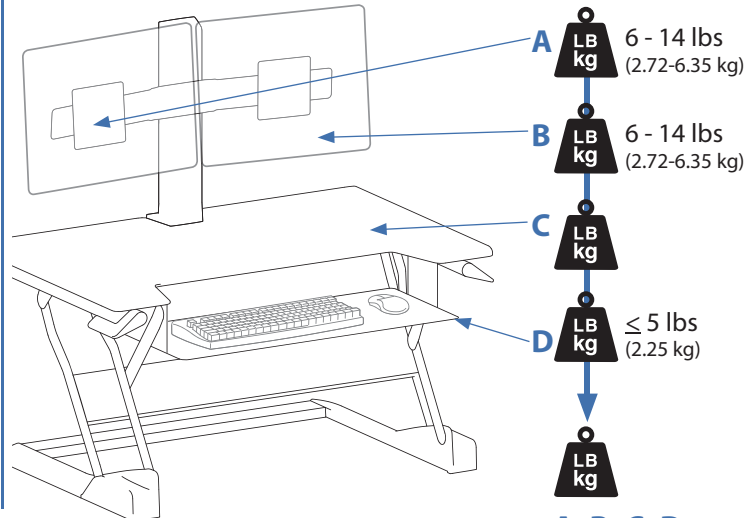

$$A+B+C+D \leq 25.3 \text{ lbs (11.48 kg)}$$

© 2014 Ergotron, Inc. rev. 10/06/2014 DIM-WFRiserDual Content is subject to change without notification

#### Americas Sales and Corporate Headquarters

St. Paul, MN USA  
(800) 888-8458  
+1-651-681-7600  
www.ergotron.com  
sales@ergotron.com

#### EMEA Sales

Amersfoort, The Netherlands  
+31 33 45 45 600  
www.ergotron.com  
info.eu@ergotron.com

#### APAC Sale

Tokyo, Japan  
www.ergotron.com  
apaccustomerservice@ergotron.com

#### Worldwide OEM Sales

www.ergotron.com  
info.oem@ergotron.com

